

TARIFA 2012

OPCIONES	Producción-Colocación de Vinilos	Alquiler de espacios x unidad/mes
Trasera Básica (1'78x0'75)	150,00€	150,00€
Trasera Grande (2'13x1'30)	200,00€	200,00€
Trasera Integral (2'75x2'55)	650,00€	550,00€
Laterales Básicos (Izq-4'35x0'50;DT-2'25x0'50;DD-1'25x0'50)	250,00€	250,00€
Laterales Grandes (Izq-6'50x0'73;DT-2'60x0'73;DD-2'20x0'73)	370,00€	400,00€
Laterales Semi-integral (8'50x1'30)	915,00€	550,00€
Trasera Básica + Laterales Básicos	400,00€	400,00€
Trasera Grande + Laterales Grandes	570,00€	600,00€
Trasera Integral + Laterales Semi-integral (Medidas anteriores)	1.180,00€	750,00€
Valla Lateral Izquierdo (4'35x1'60) Microperforado homologado.	450,00€	250,00€
Vallas Lateral Izquierdo y Derecho (4'35x1'60x2) Microperforado homologado.	790,00€	450,00€

Descuento adicional por cantidad de unidades contratadas: De 5 a 9 unidades: 5% - Diez o más: 10%

Otros Formatos y Ofertas - Consultar

INFORMACIÓN Y VENTA:

Antonio Estupiñán González

 **928 887 841 - 639 991 323**
comercial@mimus.es

Viera y Clavijo, 23, 2º A 35002 Las Palmas de Gran Canaria

Trasera Básica

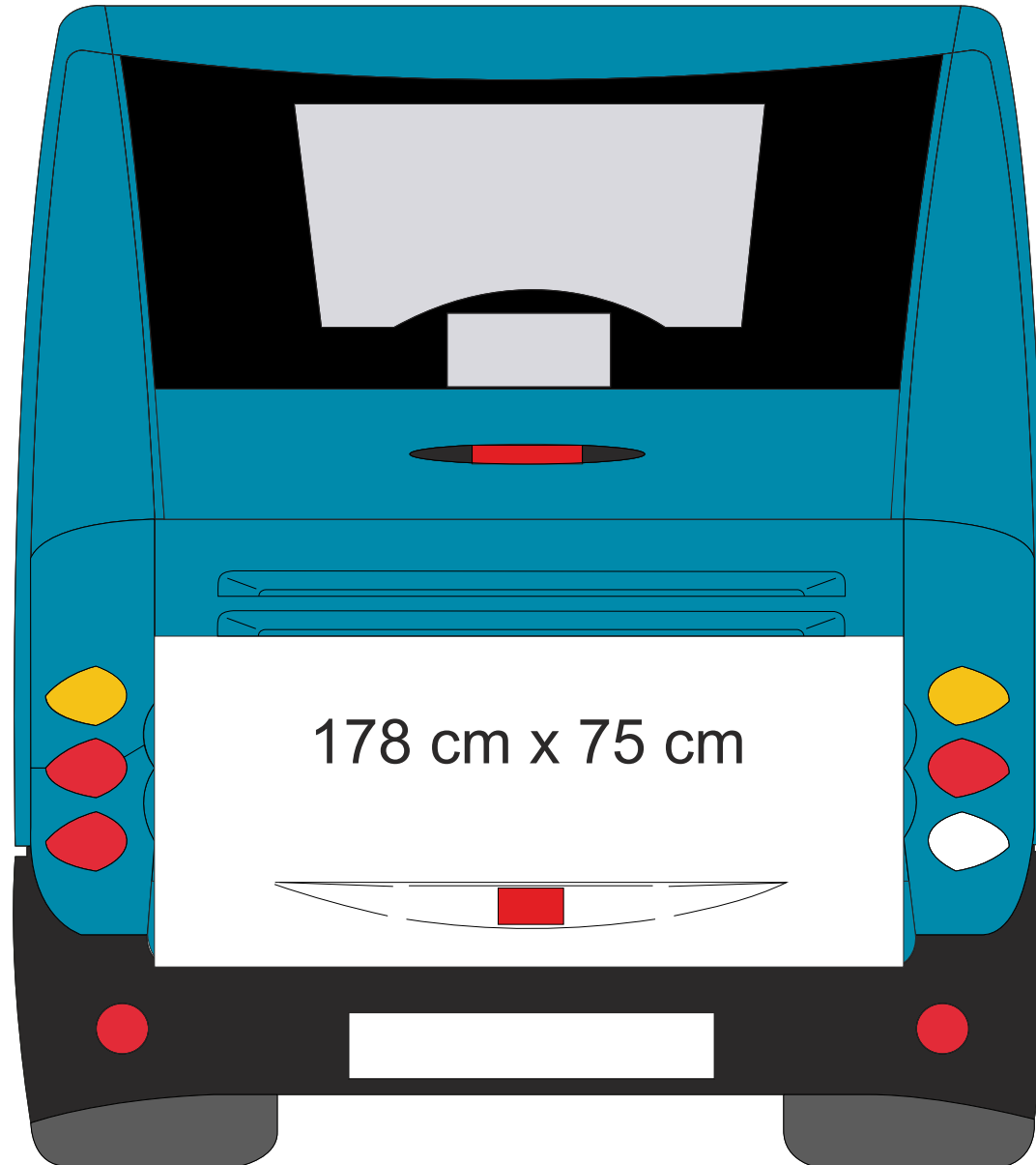

Trasera Grande

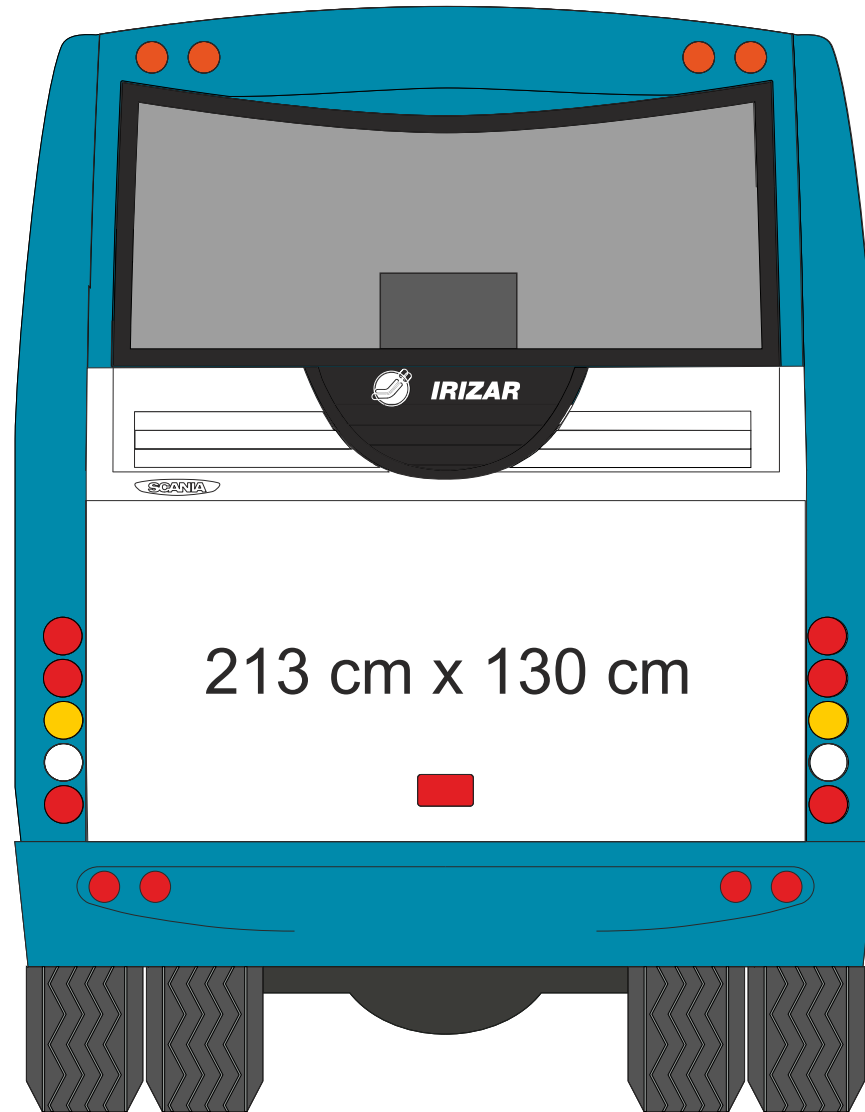

Trasera Integral

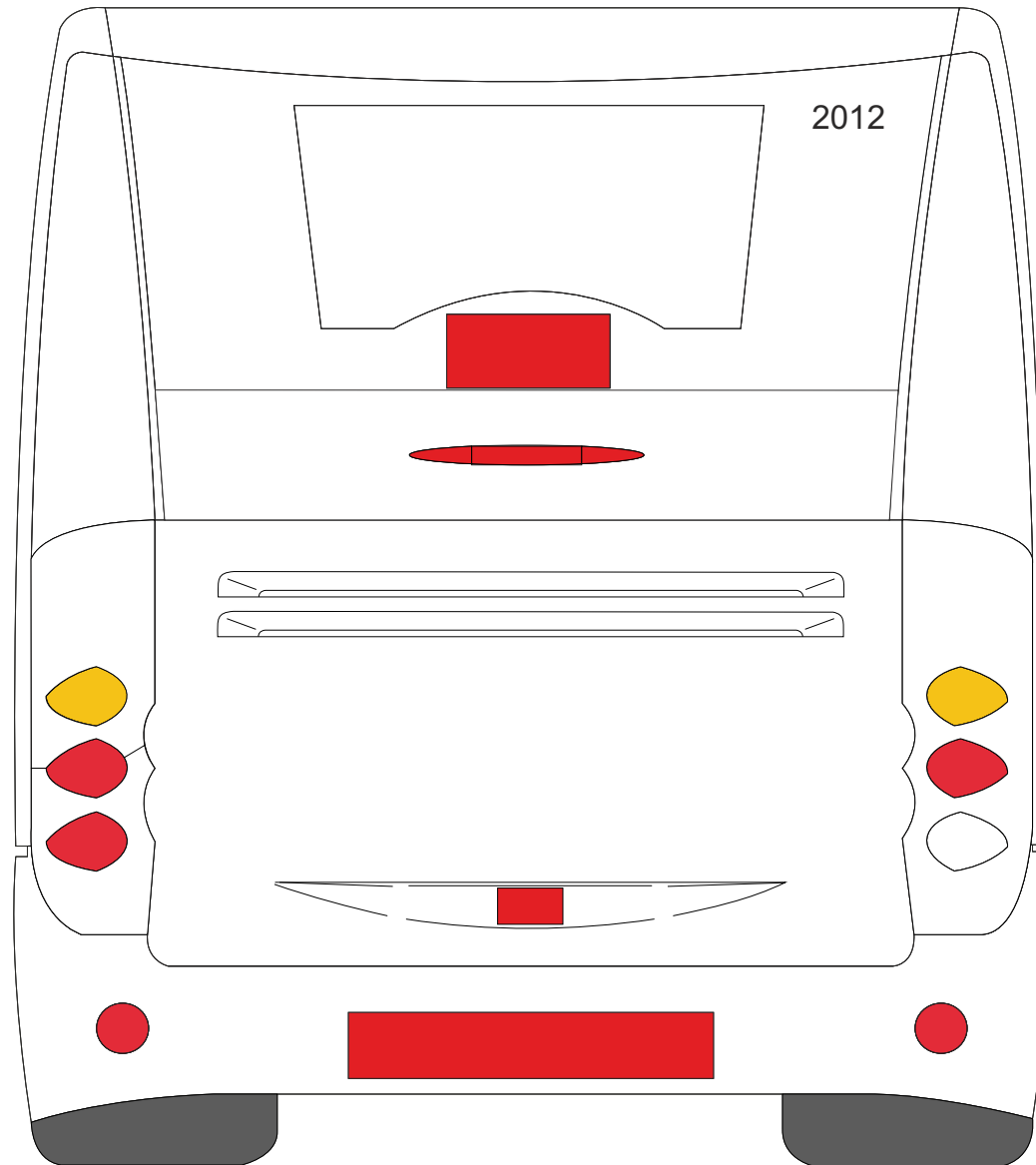

Laterales Básicos

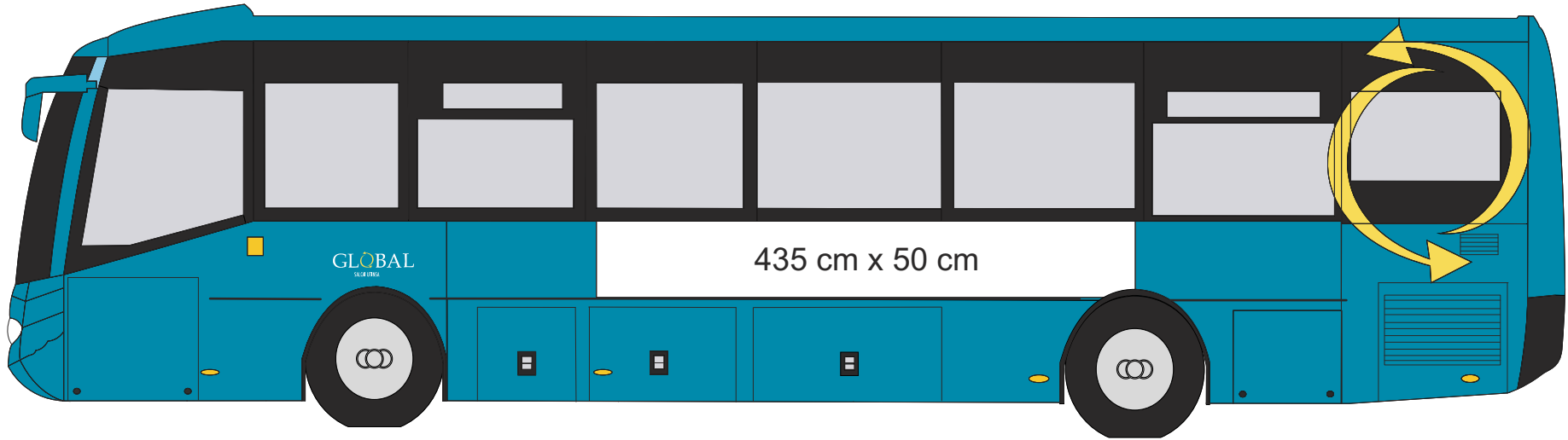

Laterales Grandes

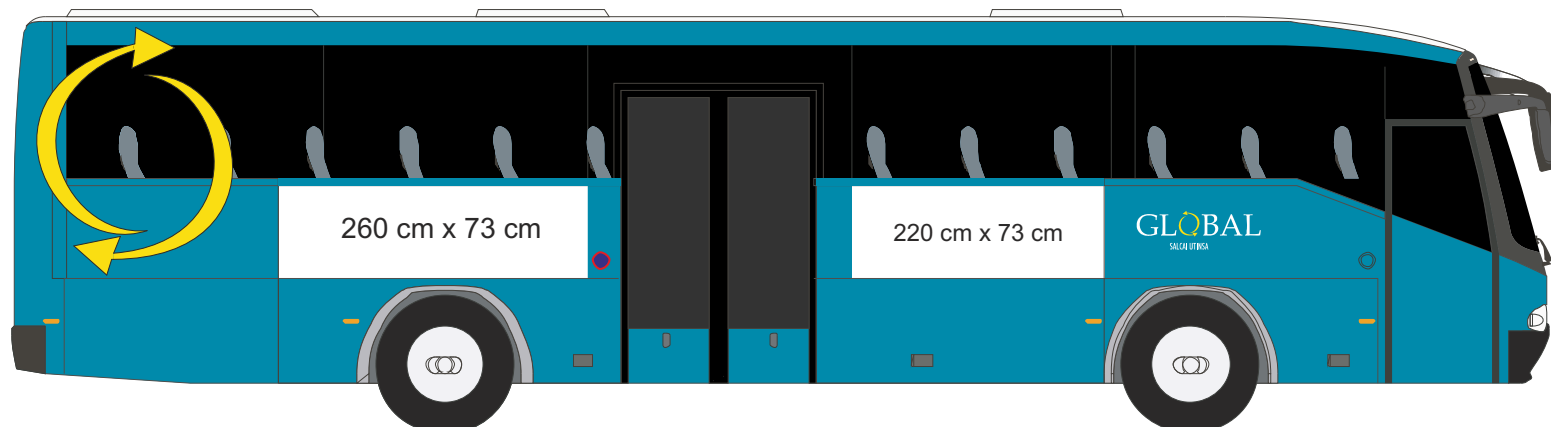
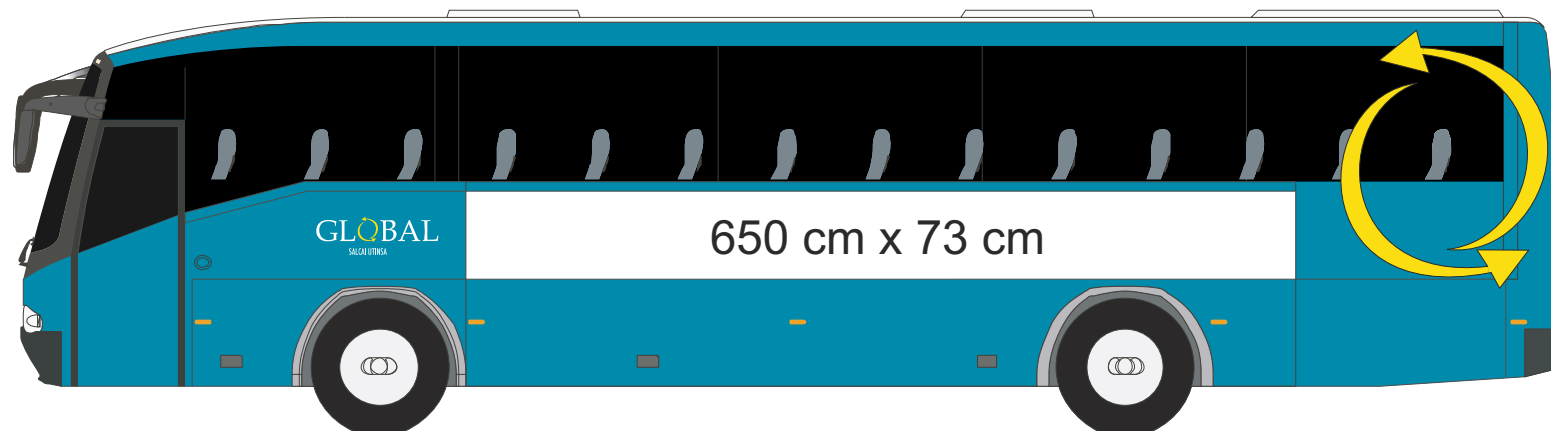

Laterales Semi-integrales

850 cm x 130 cm

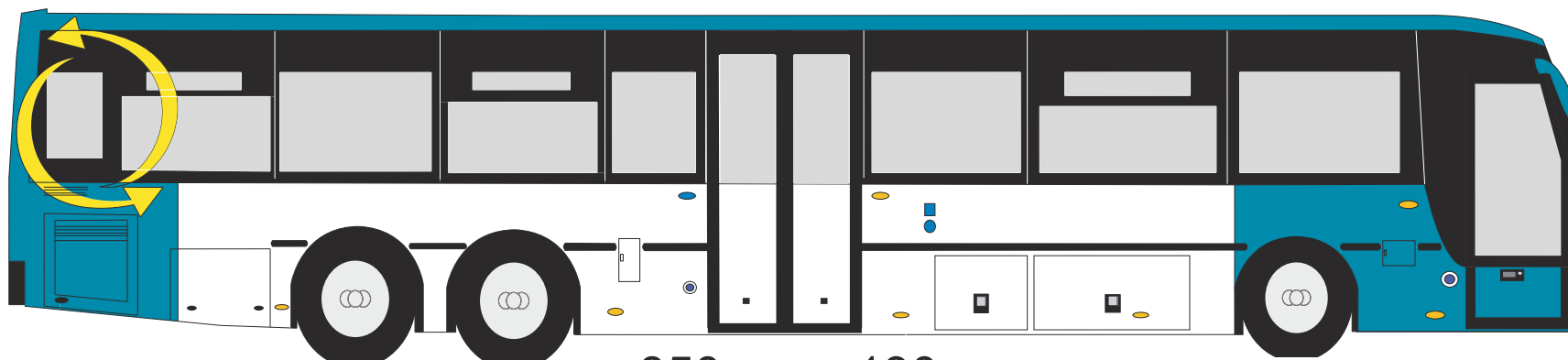
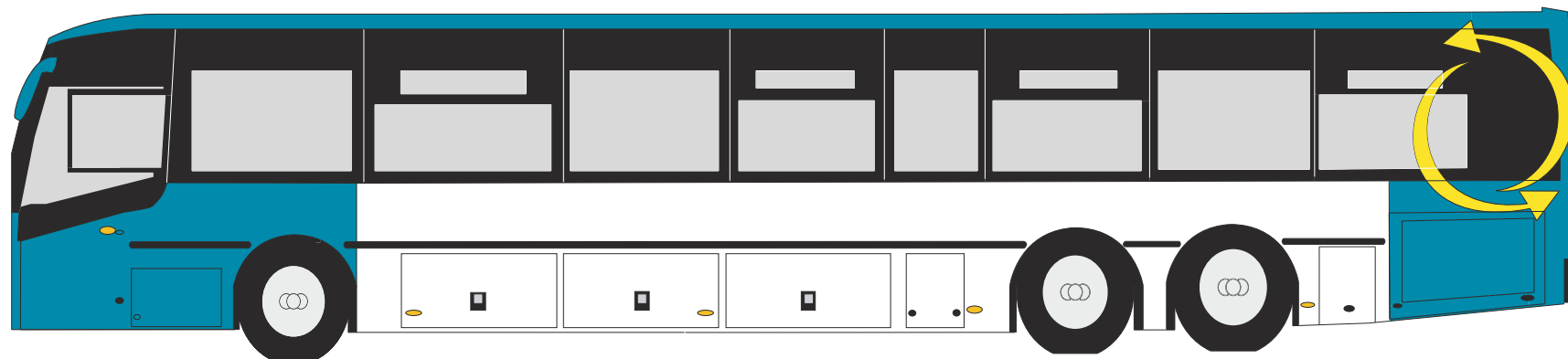

850 cm x 130 cm

Trasera Básica + Laterales Básicos

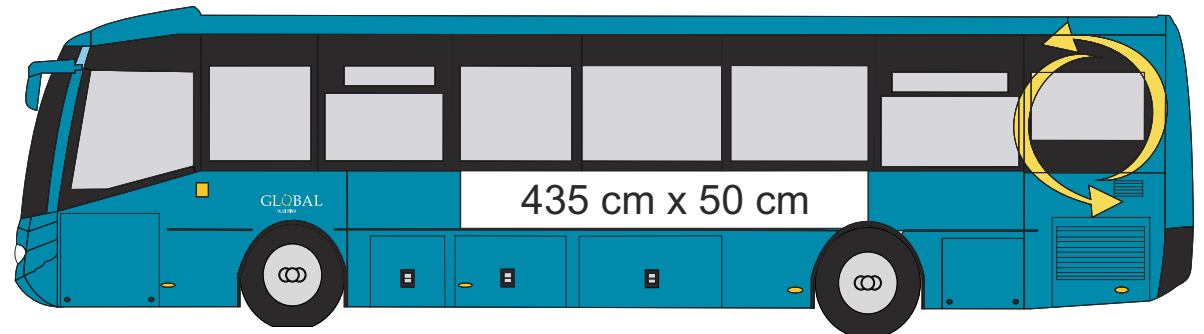
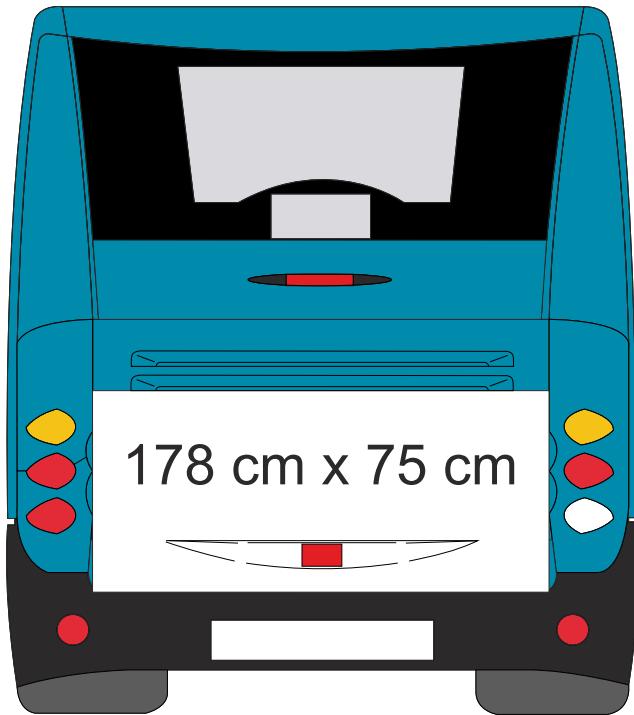

Trasera Grande + Laterales Grandes

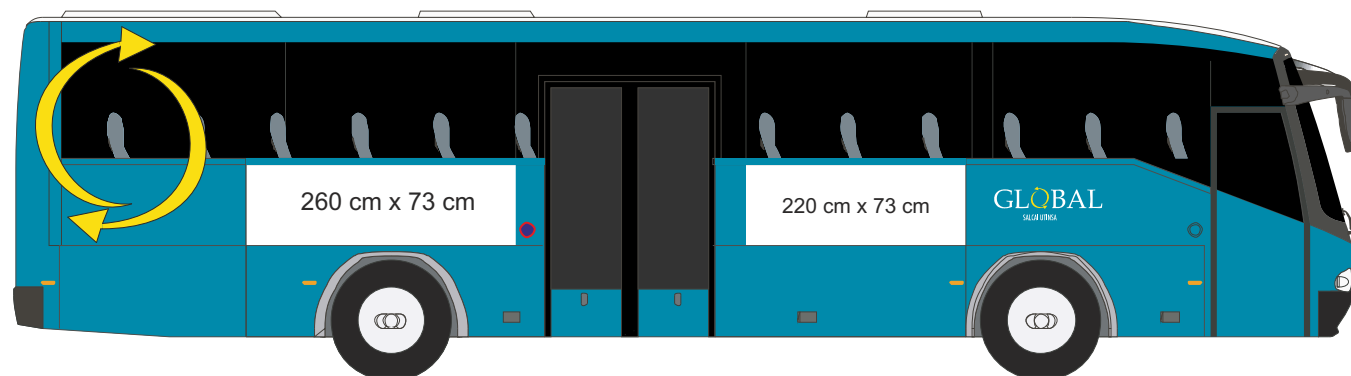
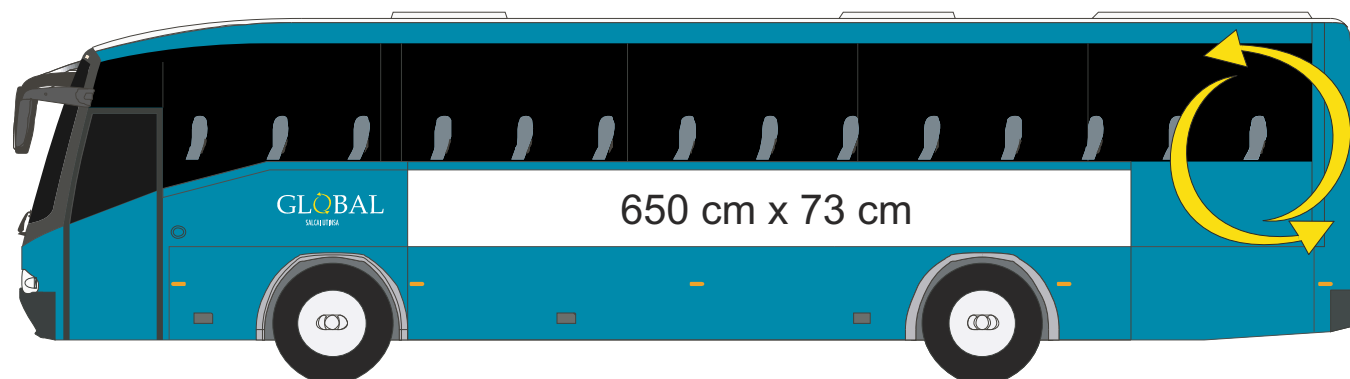
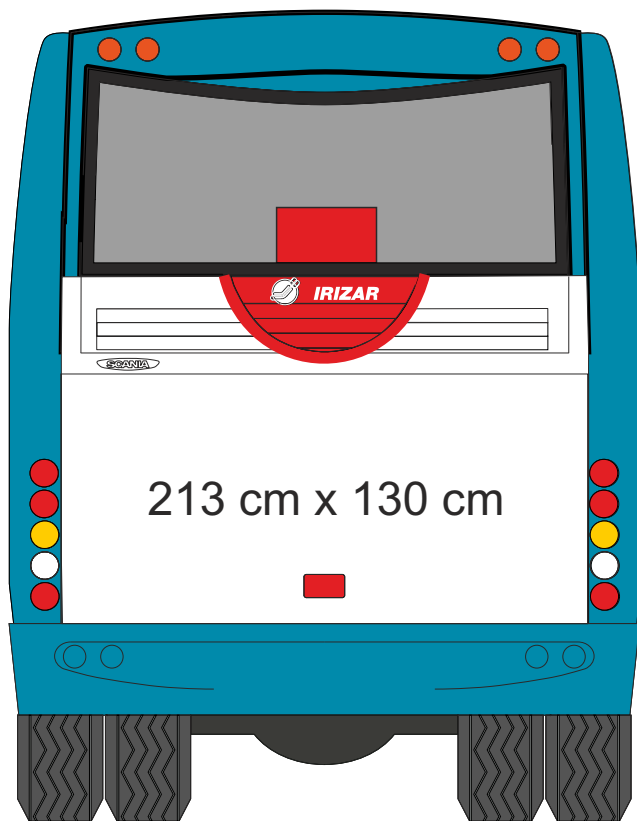

Trasera Integral + Laterales Semi-integrales

275 cm x 255 cm

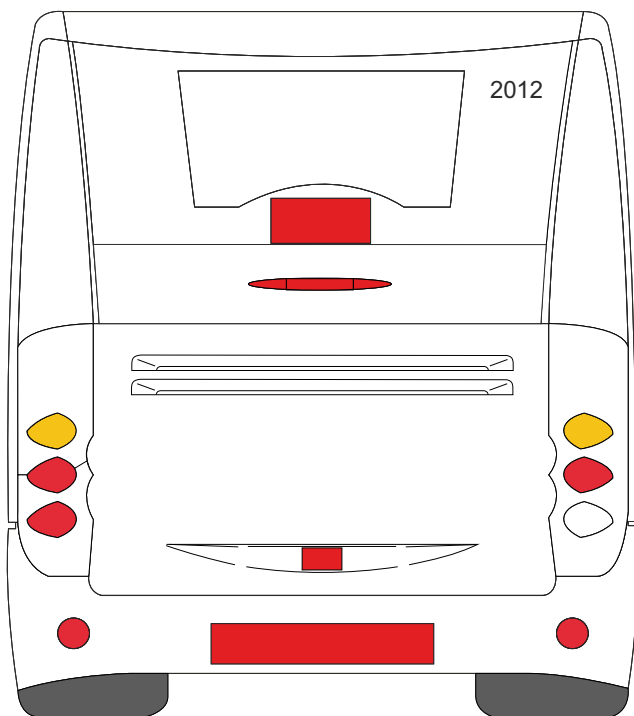

650 cm x 130 cm

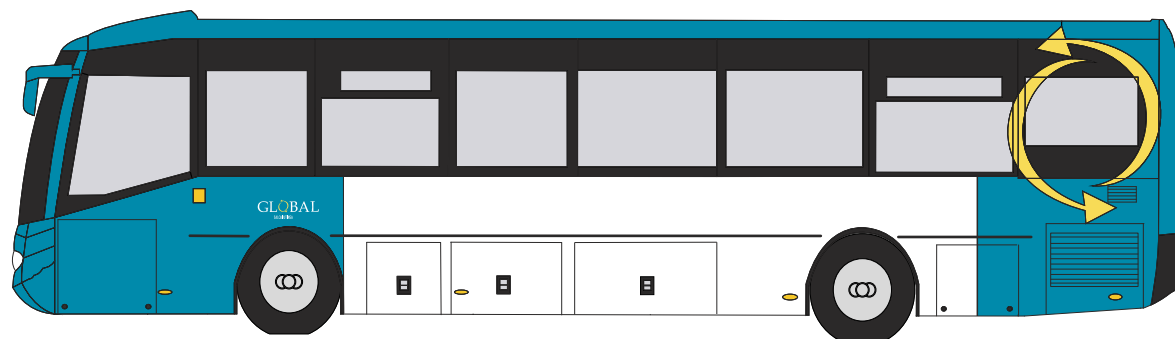

650 cm x 130 cm

Valla Lateral Izquierdo
Vinilo microperforado en cristales

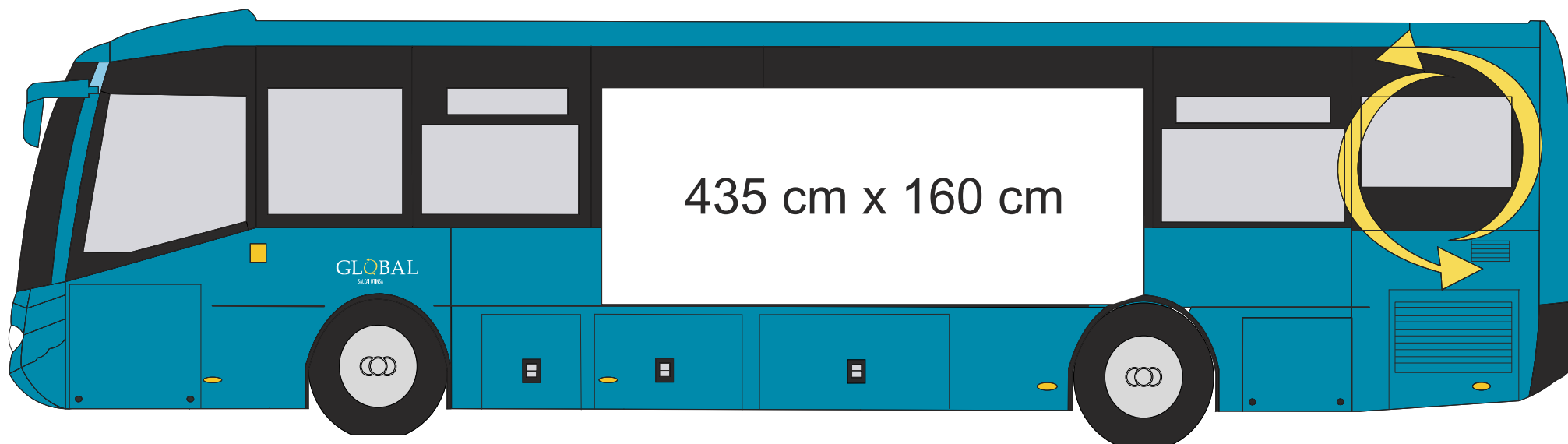

Vallas Lateral Izquierdo y derecho
Vinilo microperforado en cristales

